

Operation & Installation Guide



ANTI-THEFT SAFE®

Model 2074F / 2074EF / 2079F / 2079EF

- Read carefully
- Keep for reference
- Do not keep inside of safe

Contents

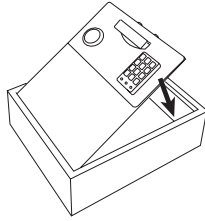

2074F, 2074EF

Or

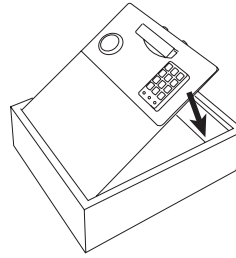

2079F, 2079EF

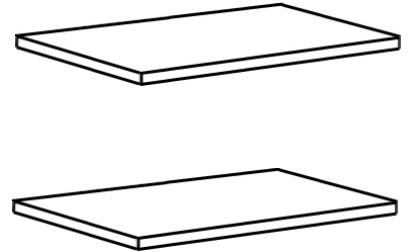
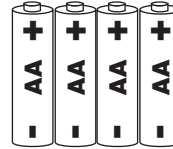
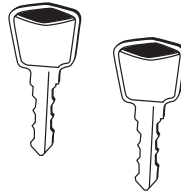
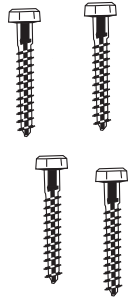
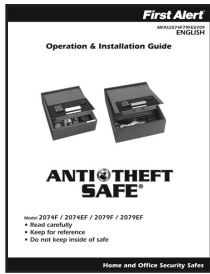

Safe Identification Record

Model Number _____ ← **1**

Serial Number _____ ← **2**

Key Number _____ ← **3**

Digital Passcode Record - Model 2074F, 2074EF, 2079F, 2079EF

Your Passcode must be at least 3 digits and no more than 8 digits followed by the letter A or B.

<input type="text"/>	<input type="text"/>	<input type="text"/>	<input type="text"/>	<input type="text"/>	<input type="text"/>	<input type="text"/>	<input type="text"/>	<input type="text"/>	A
<input type="text"/>	<input type="text"/>	<input type="text"/>	<input type="text"/>	<input type="text"/>	<input type="text"/>	<input type="text"/>	<input type="text"/>	<input type="text"/>	B

2074F, 2074EF

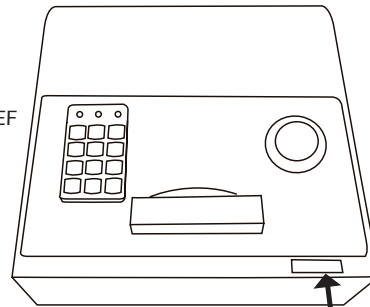

2079F, 2079EF

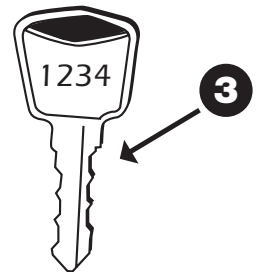
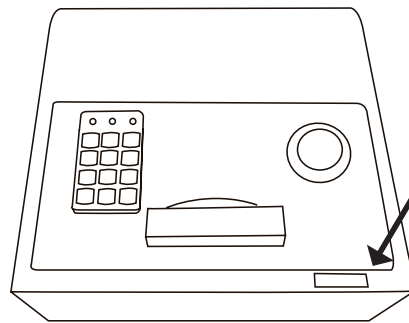

Important: DO NOT RETURN SAFE TO STORE

If you are missing parts, have difficulty programming your safe or have any other questions pertaining to its proper use and care, DO NOT RETURN your safe to the store. Please contact Consumer Affairs at 1-800-223-8566 (USA & Canada) for assistance Monday through Friday, 7:30 am to 4:30 pm Pacific Standard Time or visit our website at www.FirstAlert.com

Override key use

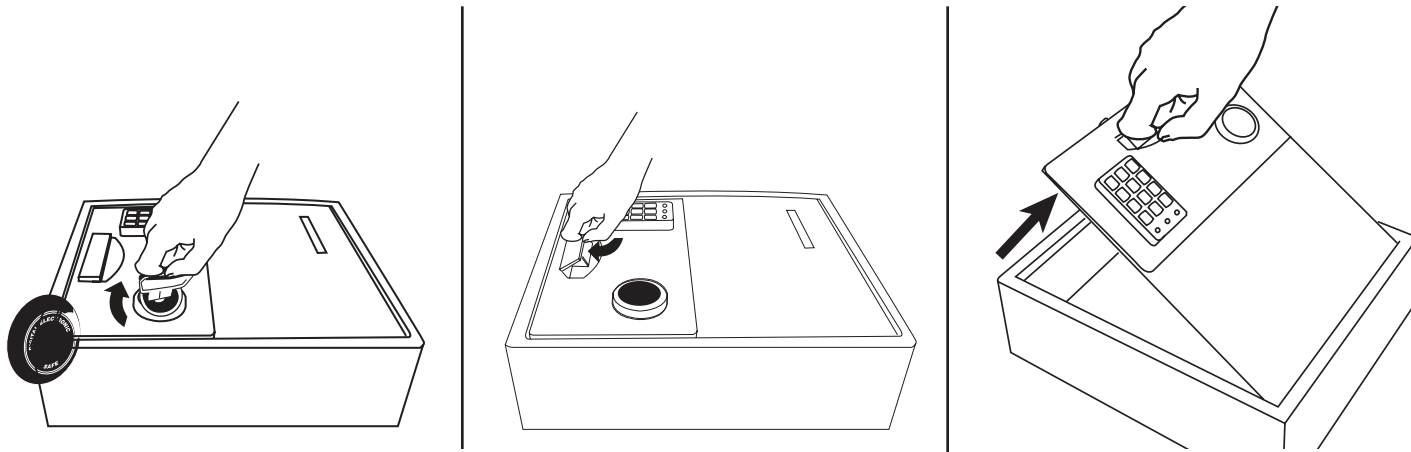

Insert Emergency Override Key into the key lock, turn to the left and pull door open

Important:

The override key is used to gain access to the safe to change batteries or if the digital lock fails to operate. This key should be stored in a secure place away from your safe.

Battery install

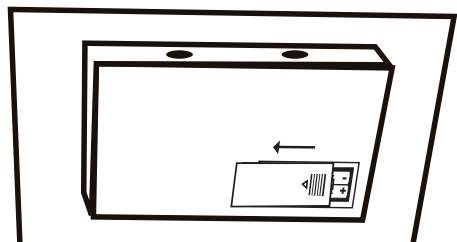

Remove battery cover

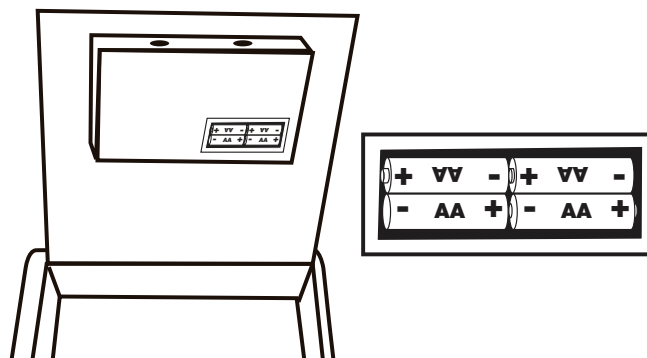

Install 4 "AA" batteries in the correct direction

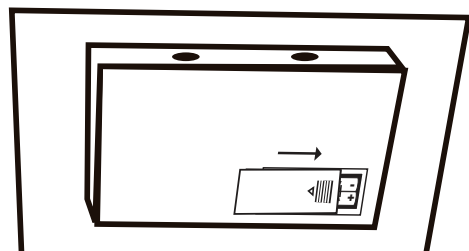

Replace battery cover.

If installed correctly:



Yellow light flashes then audible beep

Important:

Clean the battery contacts in the battery compartment and on the batteries before installing new batteries.

Programming your Personal Code

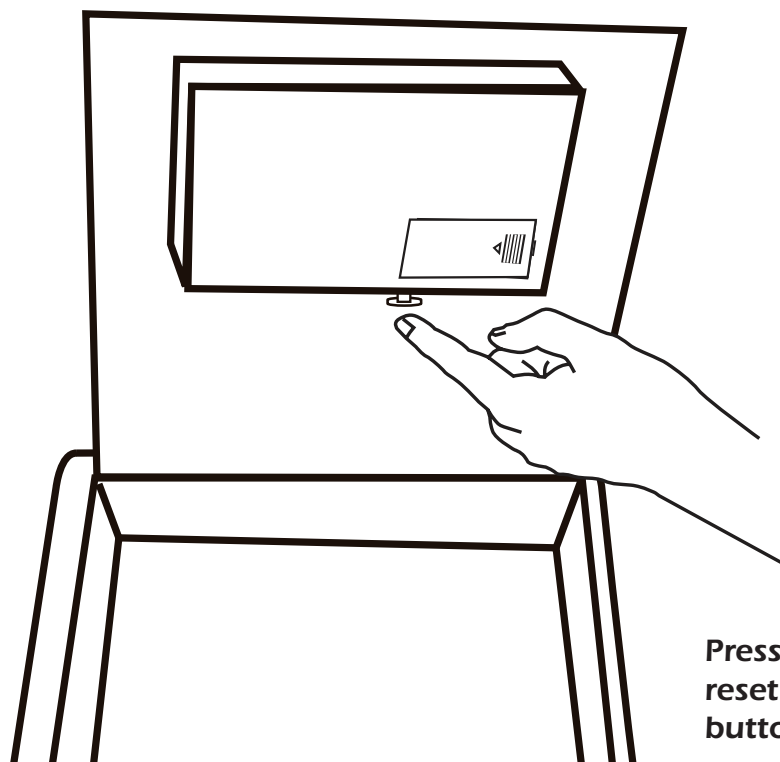

Press
reset
button

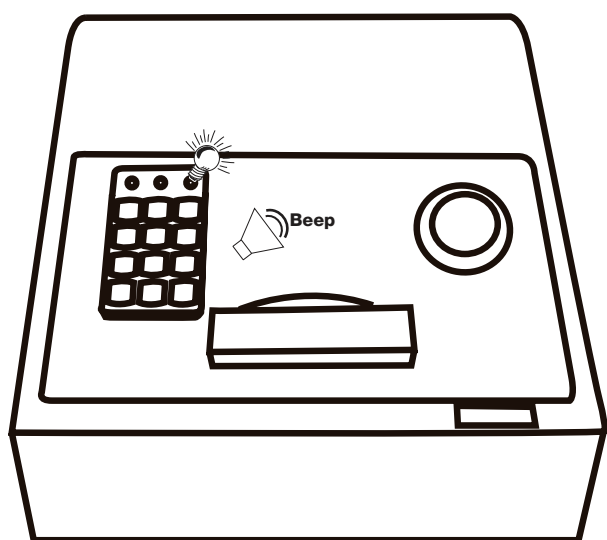

Ready light flashes
along with a beep

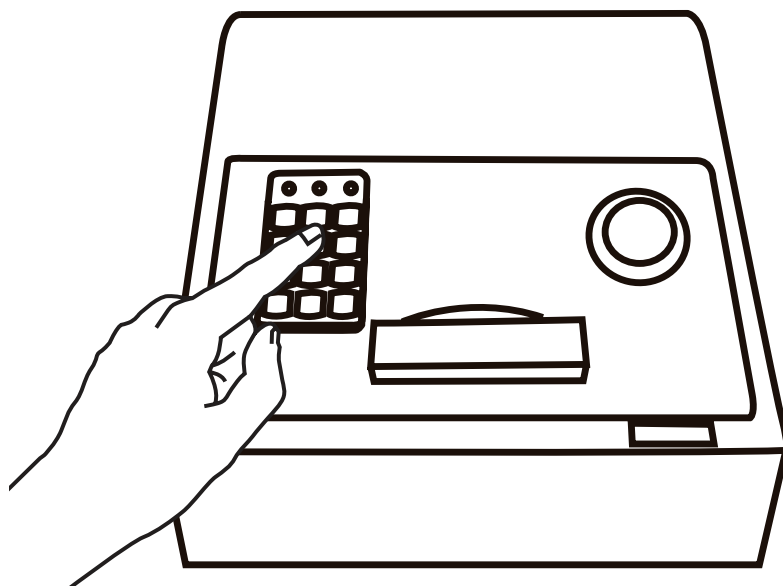

Enter new code: 3-8 digits
followed by the "A" or "B" key.
Ready light flashes along with a beep

Testing Personal Passcode

Personal Passcode entry

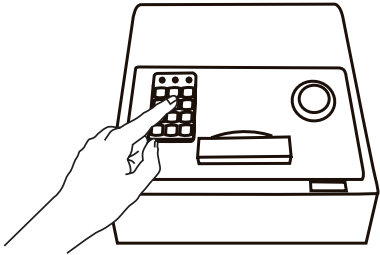

Enter new code: 3-8 digits followed by the "A" or "B" key. Ready light flashes along with a beep

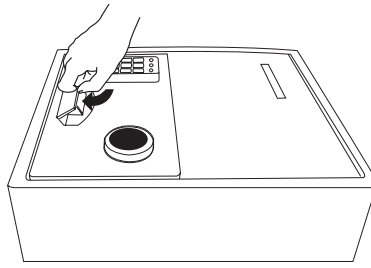
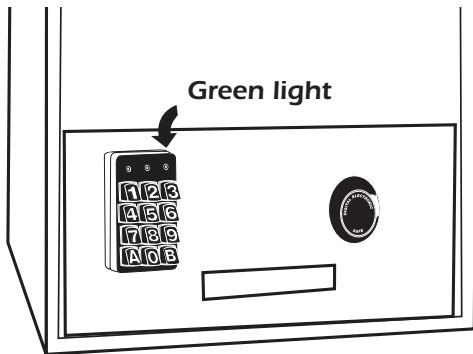

Lift the handle within 5 seconds. The safe automatically relocks in 5 seconds if you take no action

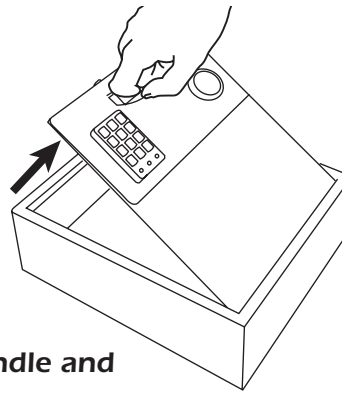

Hold the handle and pull the door open

Important:

If your safe has an interior light, the switch is located inside the safe door.
NOTE: The batteries will run down if you do not turn off the light. The light bulb is not user replaceable.

TROUBLE SHOOTING:

If safe fails to open with your Personal Passcode, try the following:

1. Check to see if the batteries have been installed properly and replace if necessary.
2. Lock-out may have occurred. Wait 15 minutes before trying again.
3. Contact SISCO / BRK Consumer Affairs Department.

SECURITY LOCK-OUT PERIODS:

For added security, the safe will automatically "Lock-out" entry for 15 minutes after three attempts to open with an invalid Passcode.

Closing safe

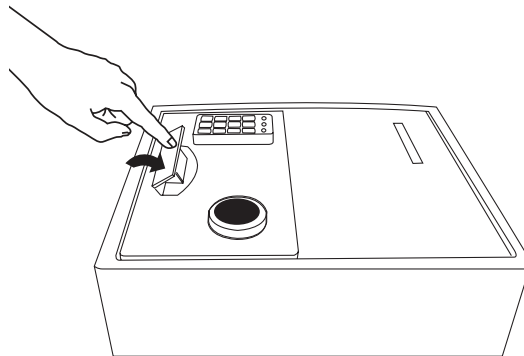
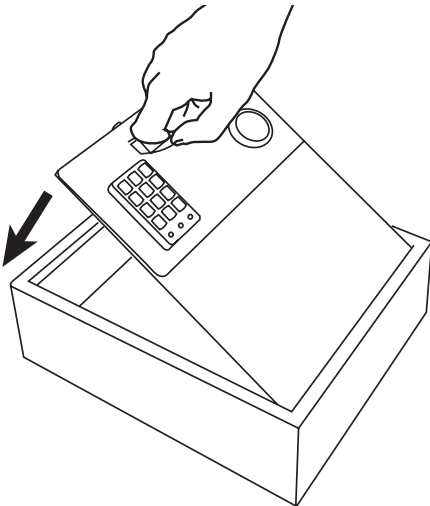

To lock the safe, press the handle down. If the handle is not fully closed, the safe will remain unlocked or will not re-open

Shelves and mounting

Shelf install

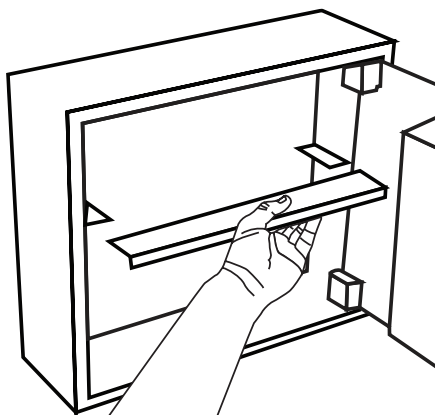

Shelf-top mounting

Place safe in the desired location and use a pencil to make drill marks on the shelf

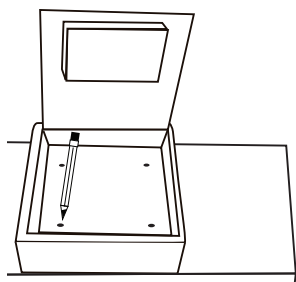

Use the safe's predrilled holes as your guide

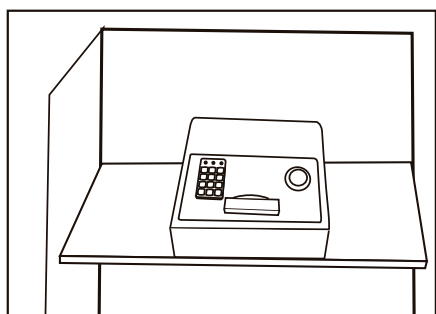
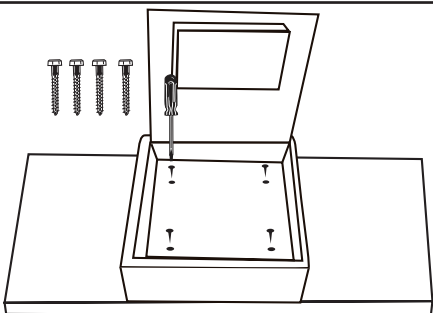
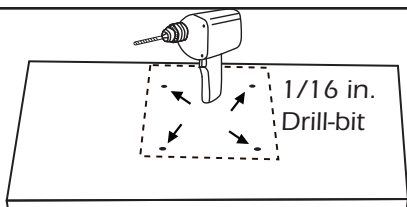

Wall mounting

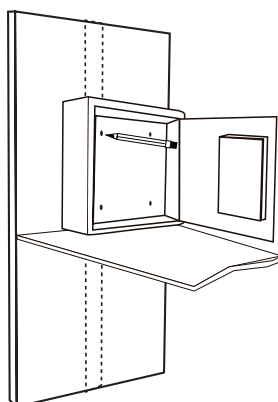

Place safe in the desired location and use a pencil to make drill marks on the shelf

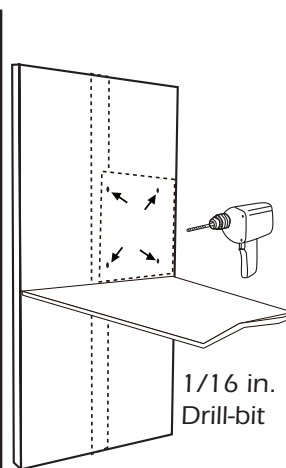

Use the safe's predrilled holes as your guide

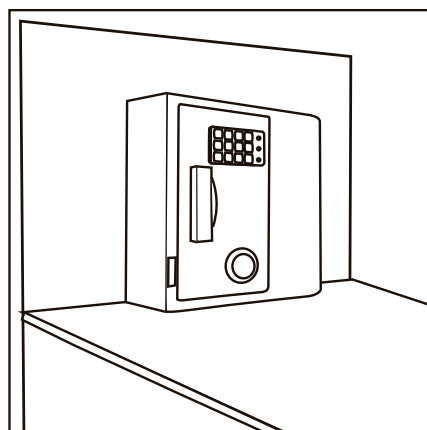
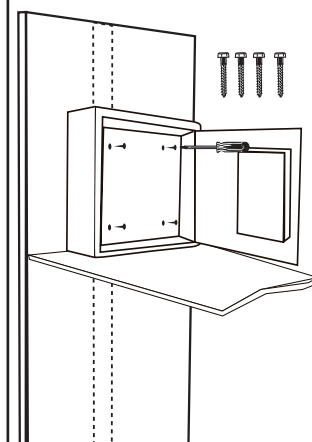

Safe Care and Maintenance

When properly maintained, your safe will continue to operate and accurately read the authorized Passcode for many years. In order to ensure optimum performance of your safe, please follow these simple precautions:

Replace Batteries – For best results and performance, we recommend that the batteries be replaced at least once a year or sooner depending on amount of use.

Clean Hands - Never attempt to operate the digital keypad if your hands have excessive dirt, debris or liquids on them.

Clean Safe – To clean the surface of your safe, it is recommended that you use a mild cleaner (e.g., window cleaner) to avoid scratching or discoloring the surface. Always wipe dry and NEVER use abrasive cleansers on the safe or digital keypad.

Moisture – We recommend that you place delicate items such as pictures or intricate jewelry into an air-tight container before storing them in your safe. Avoid placing your safe in areas of high humidity. For optimum performance, the safe should be opened and aired out for at least 20 minutes every two weeks.

For future reference, store this Operation and Installation Guide in a secure area away from the safe. DO NOT DISCARD!

How to Contact Us

Phone: 1-800-223-8566 (USA and Canada)

Monday through Friday, 7:30 am to 4:30 pm Pacific Standard Time

Mail:

Attn: Consumer Affairs Dept.

BRK / SISCO

2835 E. Ana Street

Rancho Dominguez, CA 90221

EUROPE

email: customerserviceeurope@siscoproducts.com

Ordering Replacement Keys

In the USA, replacement keys are available for a fee and credit card orders are accepted by telephone or via our web site. Checks or Money Orders are required for orders received by mail and should be made payable to SISCO. Contact our Consumer Affairs Department for costing information prior to ordering.

If a key becomes misplaced or you would like additional keys, you may conveniently purchase them from our Consumer Affairs Department. You must supply the following information to assure accurate processing:

- Name / Address / Telephone
- Safe Model Number / Serial Number
- Key Number (located on the key and on the Emergency Override Key lock)
- Number of keys requested
- E-mail address if available

Limited Warranty

BRK Brands, Inc., ("BRK") warrants that for a period of five (5) years from the date of purchase, this product will be free from defects in material and workmanship. BRK, at its sole option, will repair or replace this product or any component of the product found to be defective during the warranty period. Replacement or repair will be made with a new or remanufactured product or component. If the product is no longer available, replacement may be made with a similar product of equal or greater value. This is your exclusive warranty.

This warranty is only valid for the original retail purchaser from the date of initial retail purchase and is not transferable. You must keep the original sales receipt. Proof of purchase is required to obtain warranty performance. BRK dealers, service centers, or retail stores selling this product do not have the right to alter, modify or in any way change the terms and conditions of this warranty.

This warranty does not apply to the finish on the product. This warranty does not cover normal wear and tear of parts or damage resulting from any of the following: negligent use or misuse of the product, use contrary to the operating instructions, disassembly, repair or alteration by anyone other than BRK or an authorized service center, improper installation, or exposure to extremes of heat or humidity. Further, the warranty does not cover Acts of God, such as fire, flood, hurricanes and tornadoes.

BRK shall not be liable for any incidental or consequential damages caused by the breach of any express or implied warranty. BRK is also not responsible for: costs associated with removing or installing the product; damage or loss of the contents of the product; nor for the unauthorized removal of the contents; or damages incurred during shipment.

Except to the extent prohibited by applicable law, any implied warranty of merchantability or fitness for a particular purpose is limited in duration to the duration of the above Warranty Period. Some states, provinces or jurisdictions do not allow the exclusion or limitation of incidental or consequential damages or limitations on how long an implied warranty lasts, so the above limitations or exclusion may not apply to you. This warranty gives you specific legal rights, and you may also have other rights that vary from state to state, or province to province, or jurisdiction to jurisdiction.

USA

Mail:
Customer Service Dept.
BRK / SISCO
2835 E. Ana Street
Rancho Dominguez, CA 90221
1-800-223-8566

EUROPE

email: customerserviceeurope@siscoproducts.com